

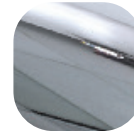

Features

- **Solid construction with heavy duty spring cassette**
Sturdy feel and consistent 90 degree lever return
- **Sculpted ergonomic lever and low friction nylon bush**
Easy to grip and smooth action
- **Complete integrated handle solution for the Vectis Plus Locking System**
No separate adaptor required
- **Patented key guide system**
To suit all profiles and sizes for ease of key alignment
- **Unique patented integral shutter system**
For complete weathersealing performance
- **Wide backplate Lever Lever or Lever Pad designs**
To suit the Vectis Plus Multi Point Lock
- **Supplied with screw and spindle pack to either suit 60-70mm PVCu profiles or 44mm doors**
Everything needed for installation included
- **Colour coordinated screw heads**
Perfectly matching hardware, even down to the smallest details
- **Supplied fully assembled**
Simple and quick installation, no need to fit springs or lever
- **Supplied with care instructions**
Helps the homeowner to keep the hardware in optimal condition
- **Silicon Site-Protectors available**
Ensures perfect condition after installation
- **Each part packaged in a separate chamber, but supplied as a set**
No scratching of parts during transit



Hardex
Chrome

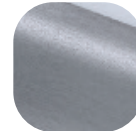

Hardex
Graphite



White

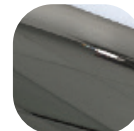

Hardex
Bronze

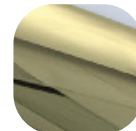

Hardex
Gold



Black

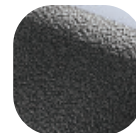

Antique
Black

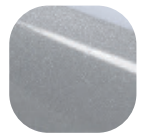

Silver

Ordering Details

Product

Balmoral Inline Lever Lever

Finish	44mm Doors	70mm Doors
	Inline Lever / Lever	Inline Lever / Lever
Hardex Chrome	1D620	1D600
Hardex Bronze	1D622	1D602
Hardex Gold	1D623	1D603
Hardex Graphite	1D625	1D605
Antique Black	1D624	1D604
White	1A620	1A600
Black	1A621	1A601
Silver	1A622	1A603

Balmoral Inline Lever Pad

Finish	44mm Doors	70mm Doors
	Inline Lever / Pad	Inline Lever / Pad
Hardex Chrome	-	1D650
Hardex Bronze	-	1D652
Hardex Gold	-	1D653
Hardex Graphite	-	1D655
Antique Black	-	1D654
White	-	1A650
Black	-	1A651
Silver	-	1A652

Please contact the sales office for cylinder and lock part codes

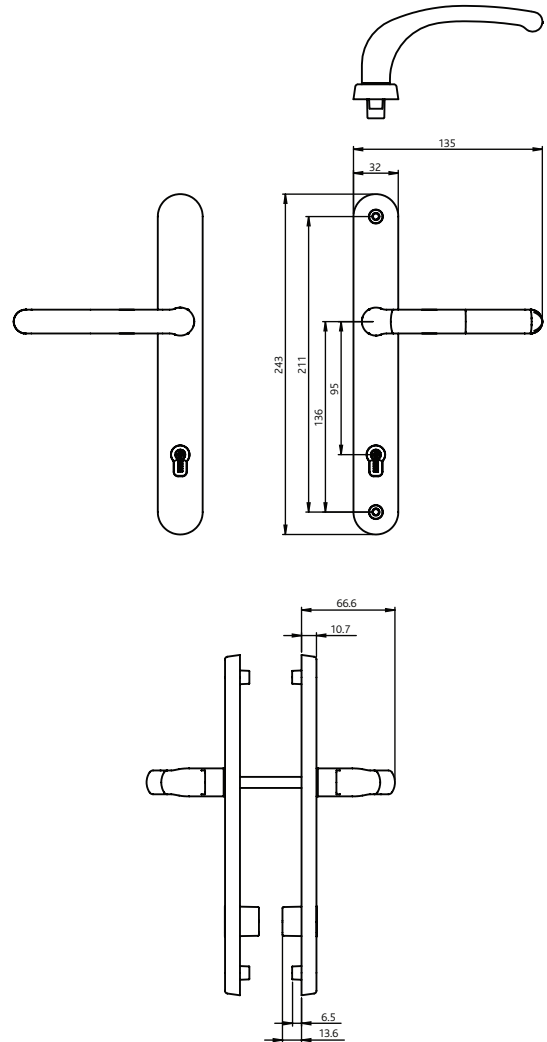

All dimensions are in mm and are nominal.
 Fab&Fix reserves the right to change specification without notice.
 It is the responsibility of the door manufacturer to ensure that the finished product meets any required safety and performance specification.

Technical Information

Corrosion resistance

Meets the requirements of BS EN 1670:2007 Grade 5 (480 hours)

Operation

Function test to 200,000 cycles

Performance

Tested to meet the requirements of PAS 24 as part of a compliant door set

Material Specification

Handle Grip and Backplate:	High quality Zinc / Aluminium
Coatings:	Hardex Chrome, Bronze, Gold, Graphite, Antique Black, White, Black and Silver
Spindle / Screws:	Mild steel, screws with colour coordinated heads for handle. Option 1 - 44mm profiles (1 x 8mm x 110mm spindle; 2 x M5 x 55mm screws) Option 2 - 60mm - 70mm profiles (1 x 8mm x 120mm spindle; 2 x M5 x 70mm and 2 x M5 x 80mm screws)

Packaging

Handles

Individually boxed with screws, spindle and care instructions. 15 handles in an outer box.

Maintenance

For continued protection of the quality finish and appearance, we advise routine cleaning of all our external hardware. We recommend wiping it with a clean cloth soaked in warm water and mild detergent every month. Please refrain from using heavy-duty cleaners, containing Chlorine or Potassium. Moving parts should also be lightly lubricated using a light non-acidic mineral oil (e.g., "3 in 1") at least twice per year. The product may need to be adjusted and fixings tightened to ensure a satisfactory operation. This procedure is particularly essential if products are used within a 25-mile radius of coastal areas or close proximity to building sites or large industrial areas, where more frequent cleaning may be required to prevent the accumulation of corrosive contaminants.